

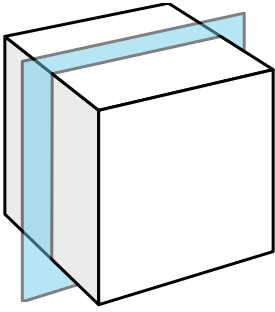

Определите получившуюся 2d фигуру, если 3d фигура будет разрезана как показано.

1)



2)

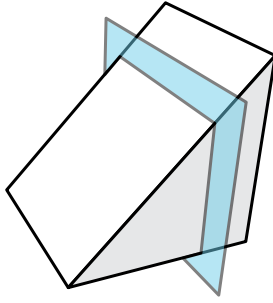

3)

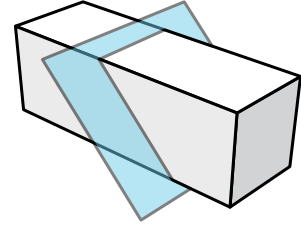

4)

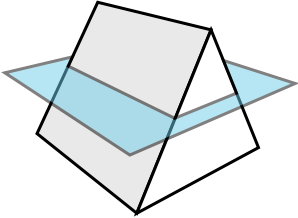

5)

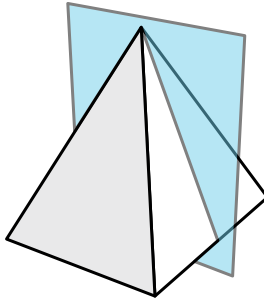

6)

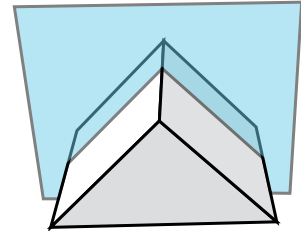

7)

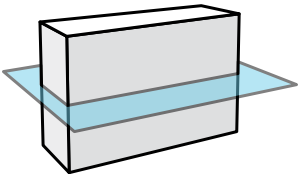

8)

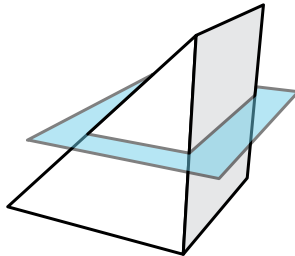

9)

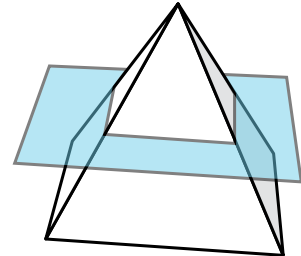



Определите получившуюся 2d фигуру, если 3d фигура будет разрезана как показано.

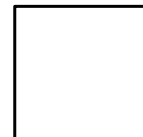
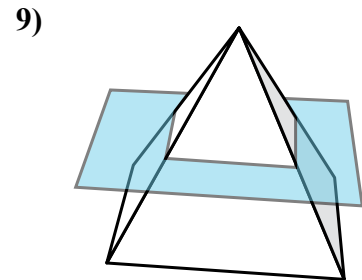
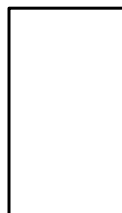
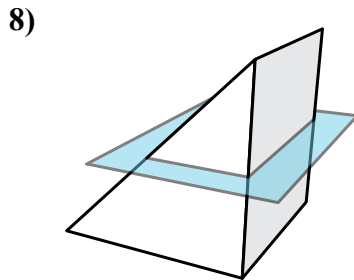
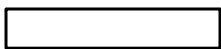
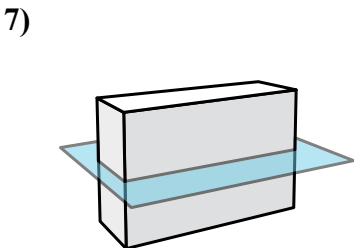
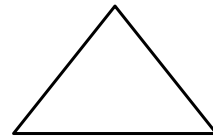
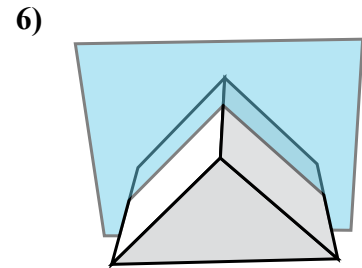
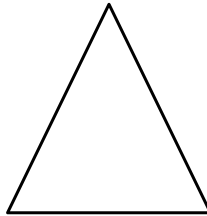
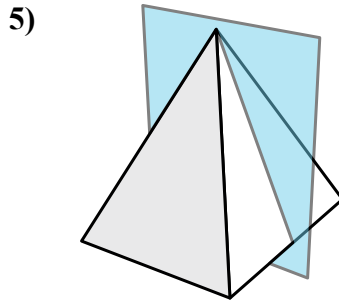
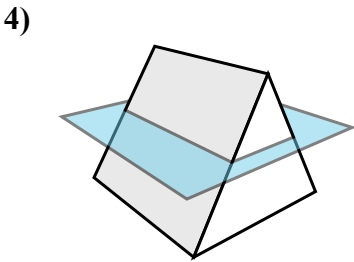
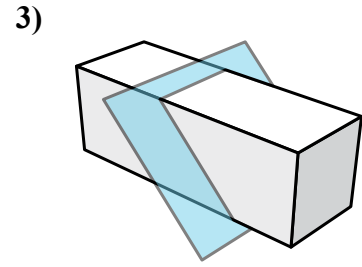
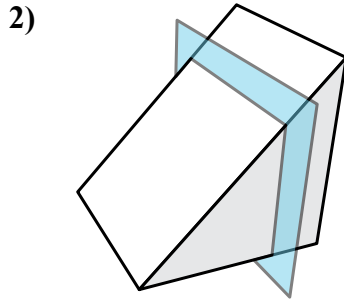
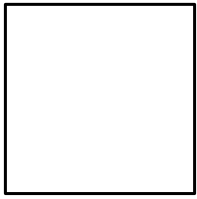
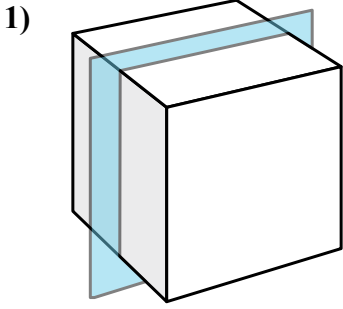



Определите получившуюся 2d фигуру, если 3d фигура будет разрезана как показано.

1)

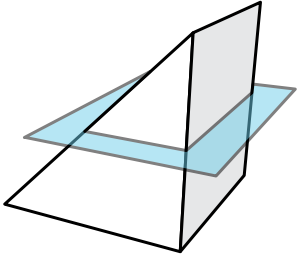

2)

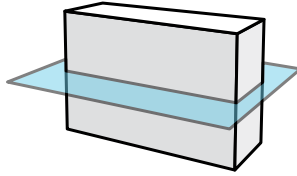

3)

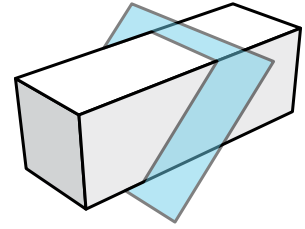

4)

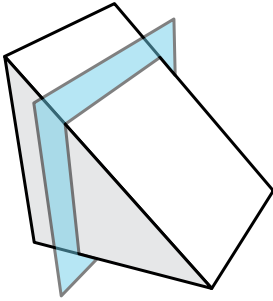

5)

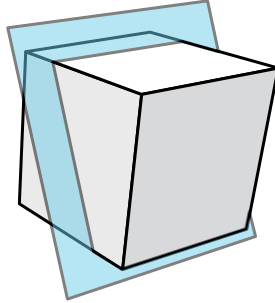

6)

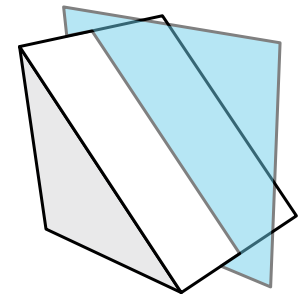

7)

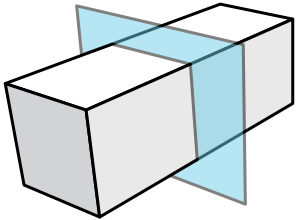

8)

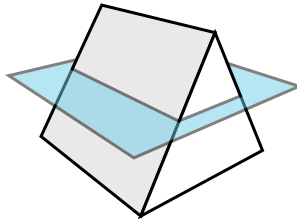

9)

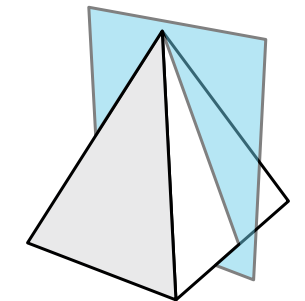



Определите получившуюся 2d фигуру, если 3d фигура будет разрезана как показано.

1)

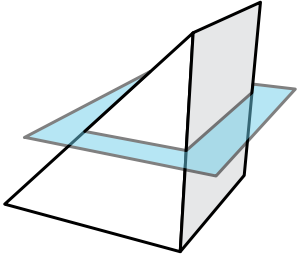

2)

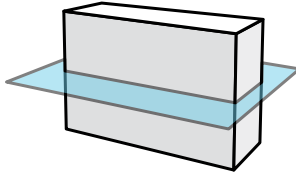

3)

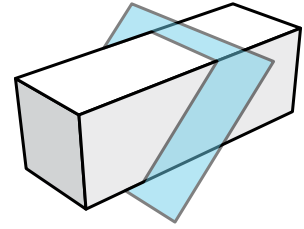

4)

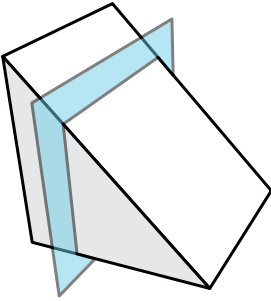

5)

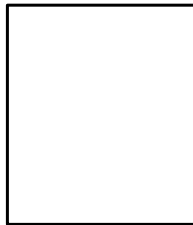
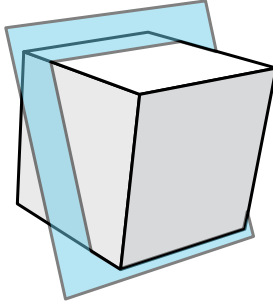

6)

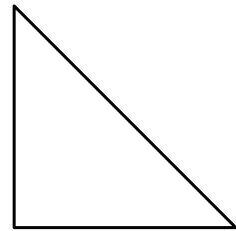
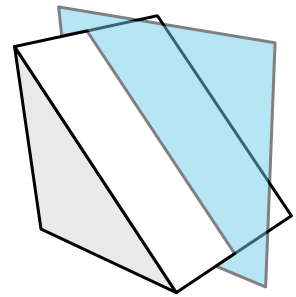

7)

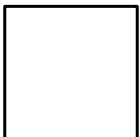
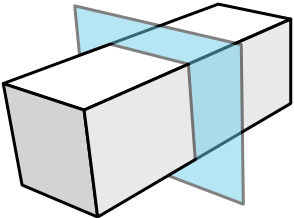

8)

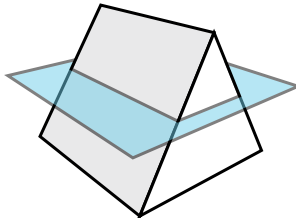

9)

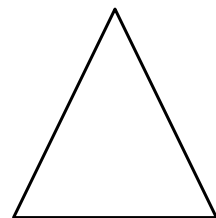
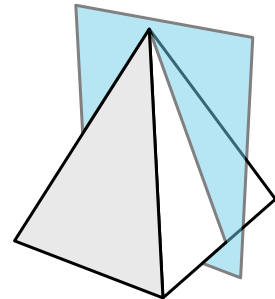



Определите получившуюся 2d фигуру, если 3d фигура будет разрезана как показано.

1)

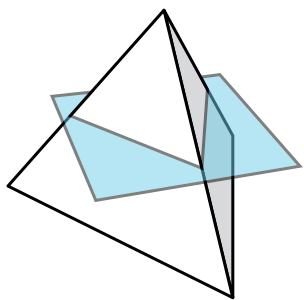

2)

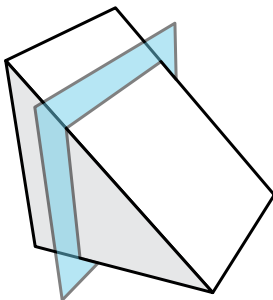

3)

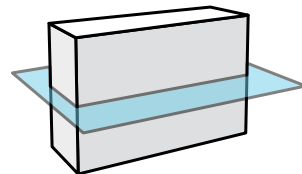

4)

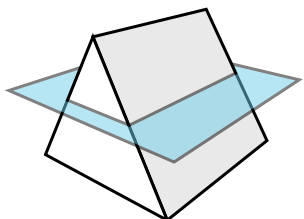

5)

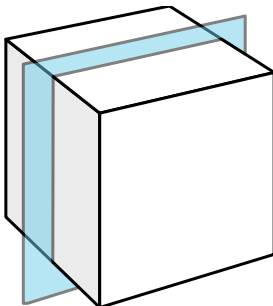

6)

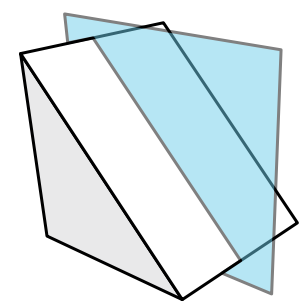

7)

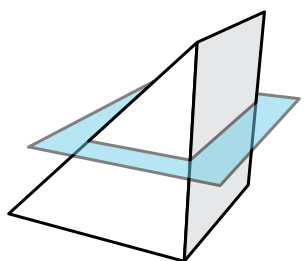

8)

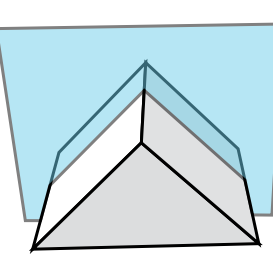

9)

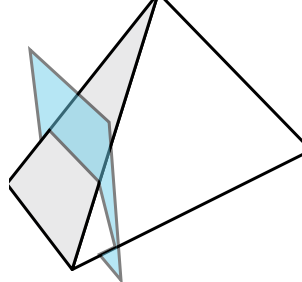



Определите получившуюся 2d фигуру, если 3d фигура будет разрезана как показано.

1)

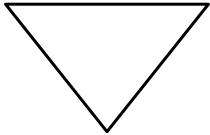
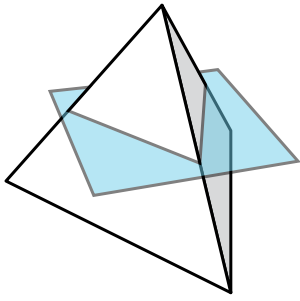

2)

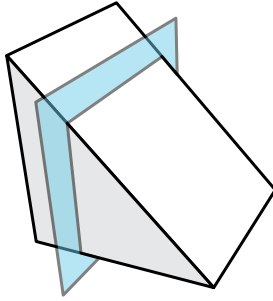

3)

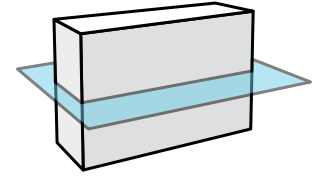

4)

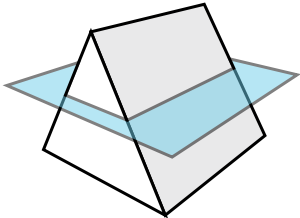

5)

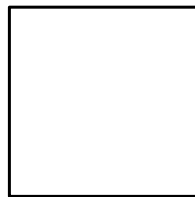
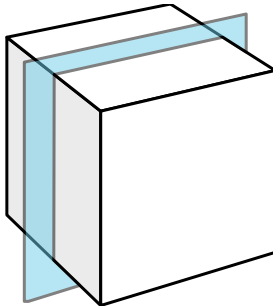

6)

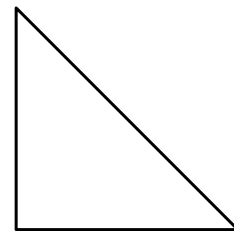
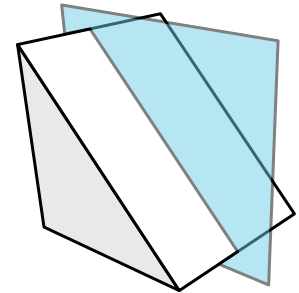

7)

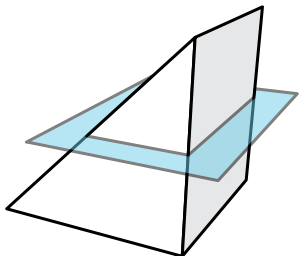

8)

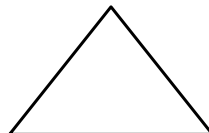
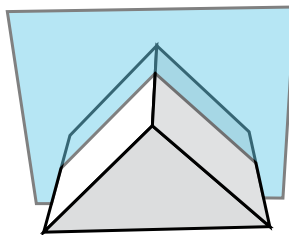

9)

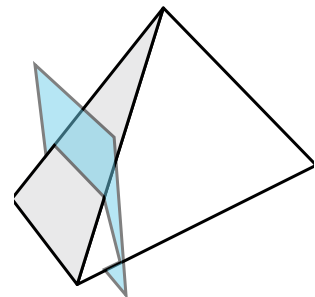



Определите получившуюся 2d фигуру, если 3d фигура будет разрезана как показано.

1)

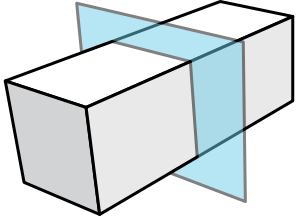

2)

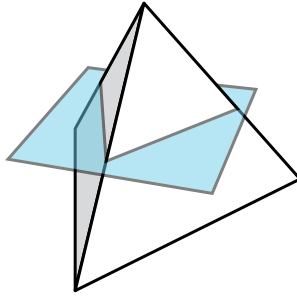

3)

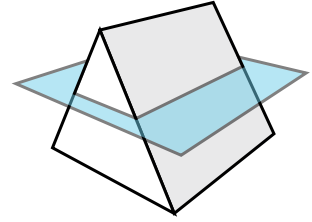

4)

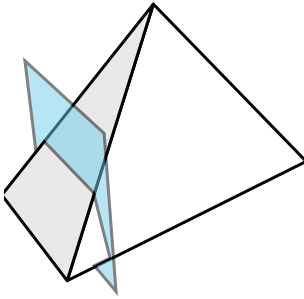

5)

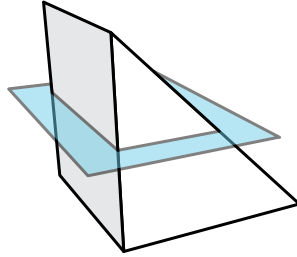

6)

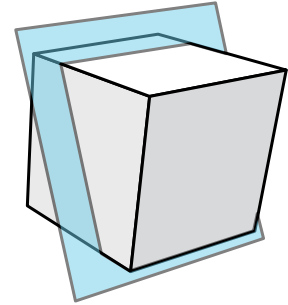

7)

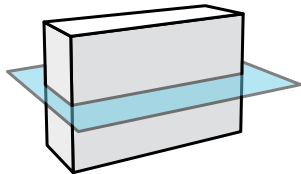

8)

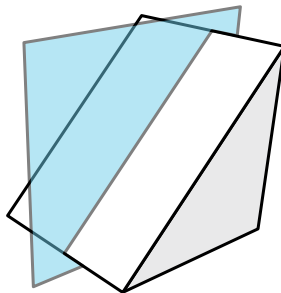

9)

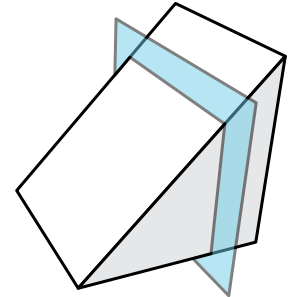



Определите получившуюся 2d фигуру, если 3d фигура будет разрезана как показано.

1)

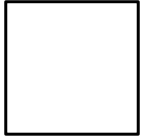
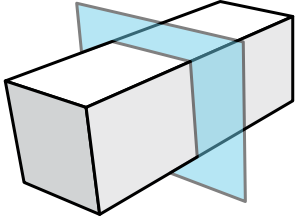

2)

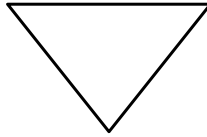
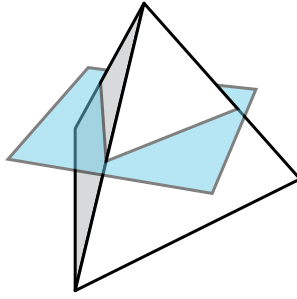

3)

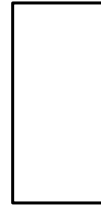
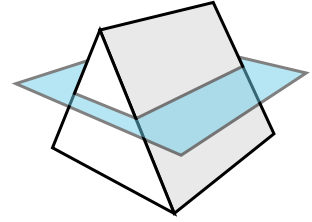

4)

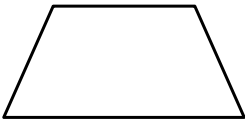
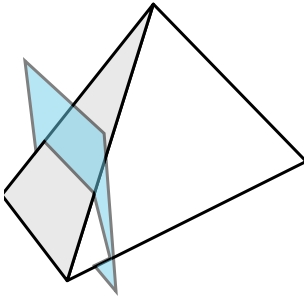

5)

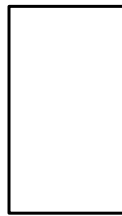
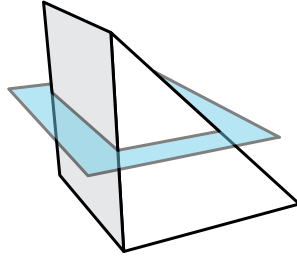

6)

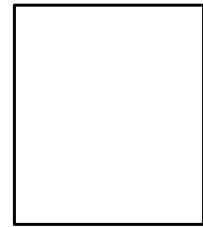
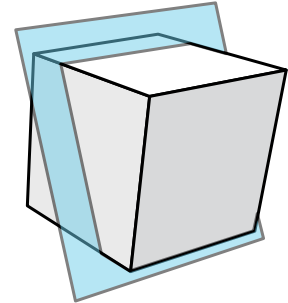

7)

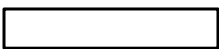
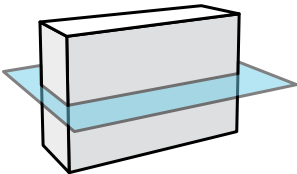

8)

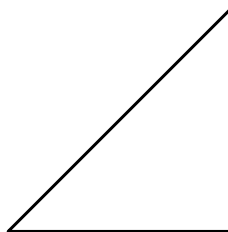
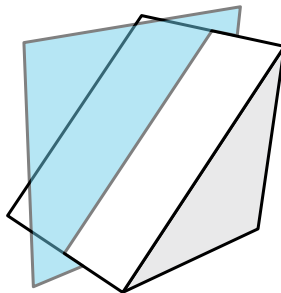

9)

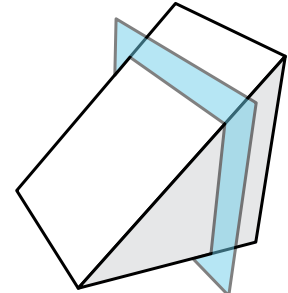





Определите получившуюся 2d фигуру, если 3d фигура будет разрезана как показано.

1)

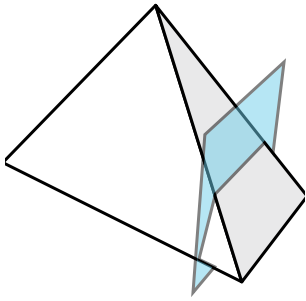

2)

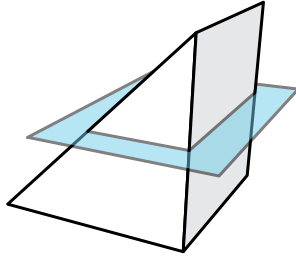

3)

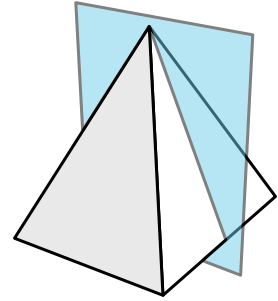

4)

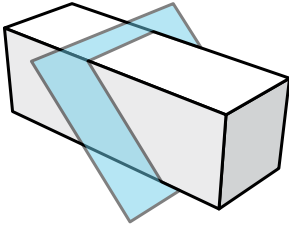

5)

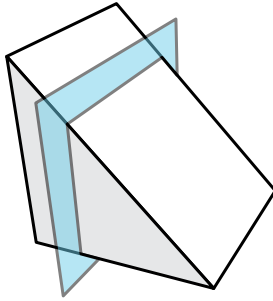

6)

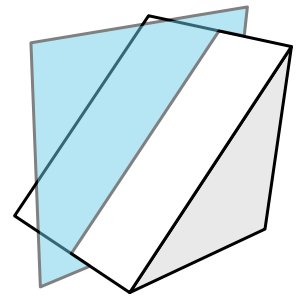

7)

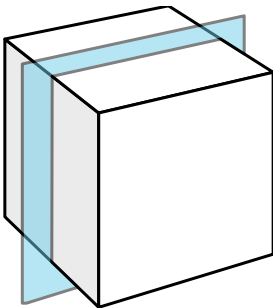

8)

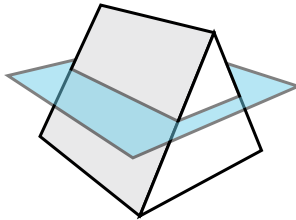

9)

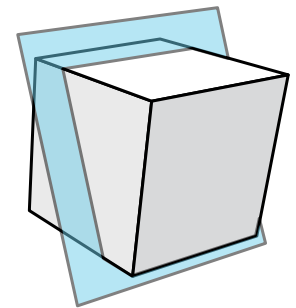



Определите получившуюся 2d фигуру, если 3d фигура будет разрезана как показано.

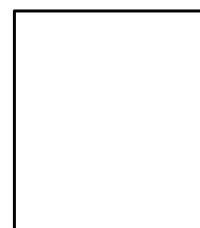
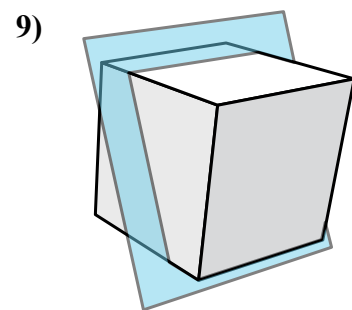
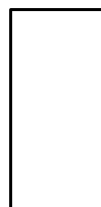
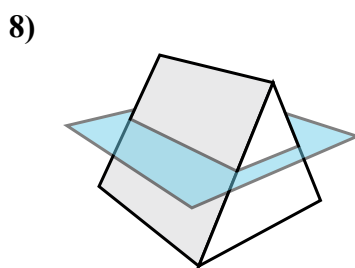
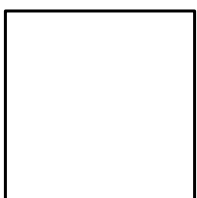
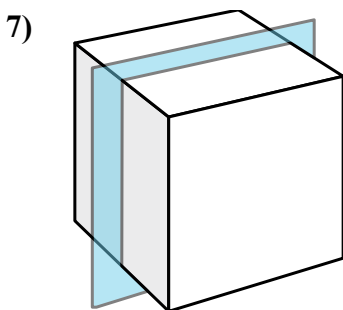
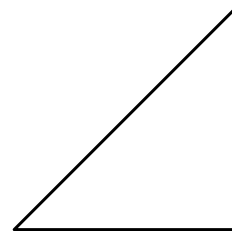
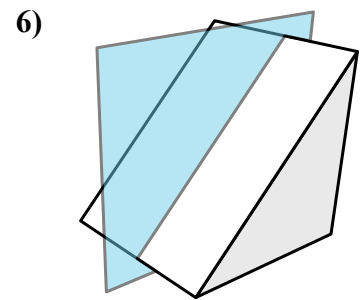
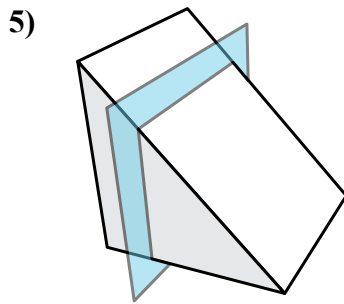
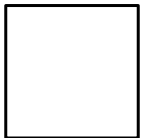
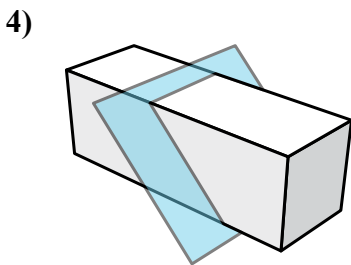
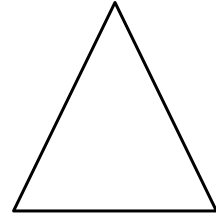
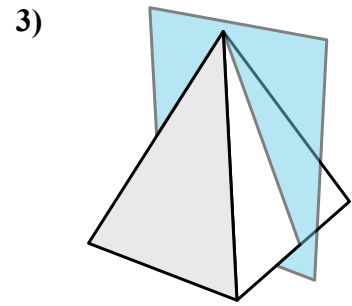
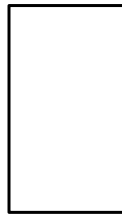
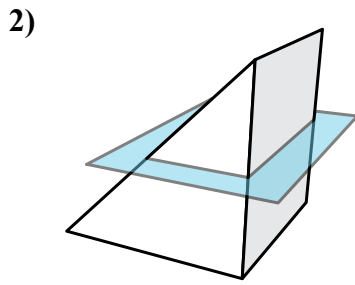
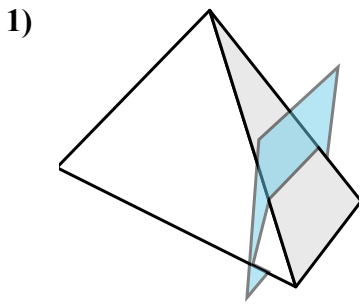



Определите получившуюся 2d фигуру, если 3d фигура будет разрезана как показано.

1)

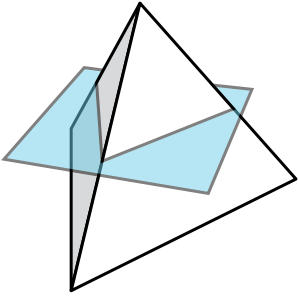

2)

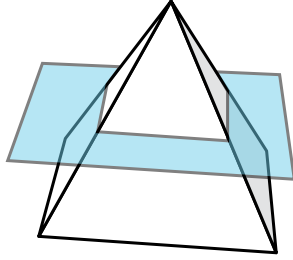

3)

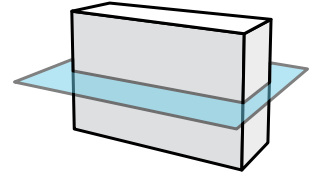

4)

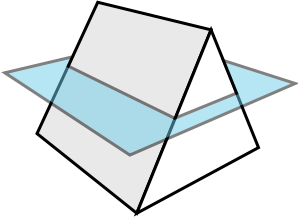

5)

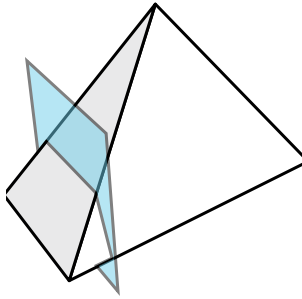

6)

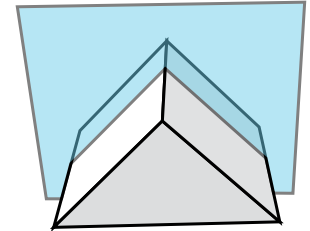

7)

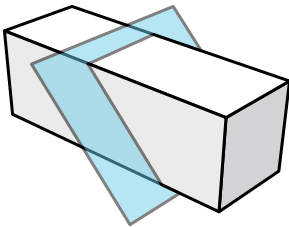

8)

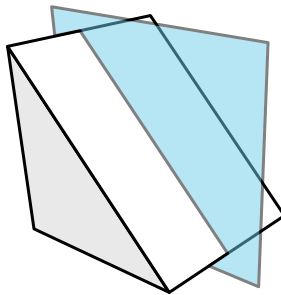

9)

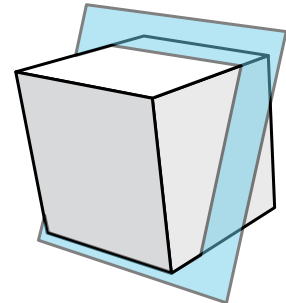



Определите получившуюся 2d фигуру, если 3d фигура будет разрезана как показано.

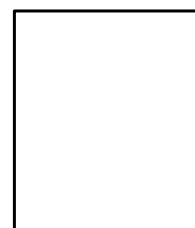
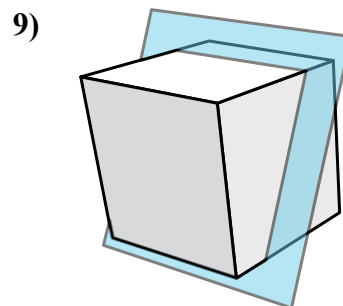
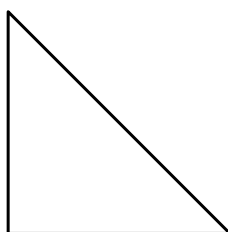
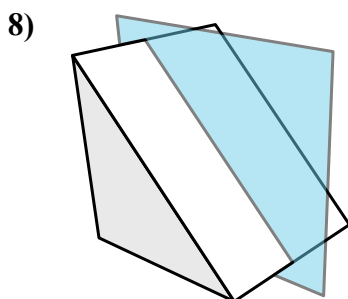
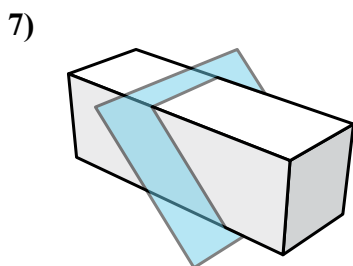
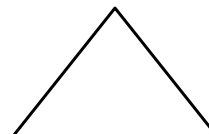
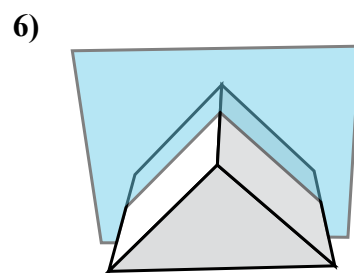
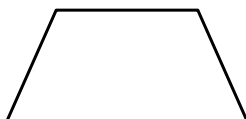
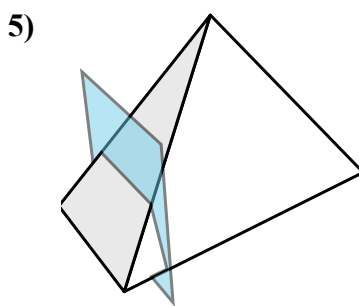
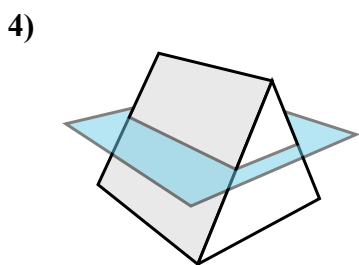
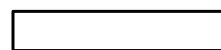
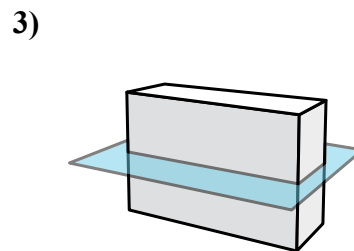
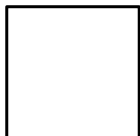
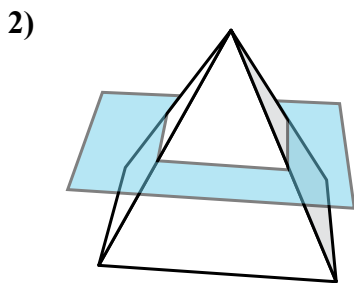
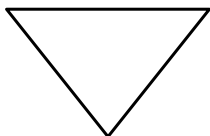
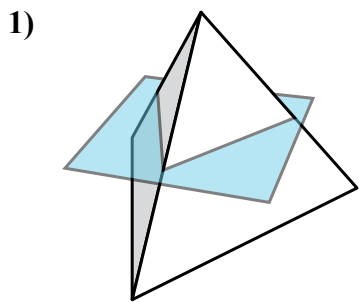



Определите получившуюся 2d фигуру, если 3d фигура будет разрезана как показано.

1)

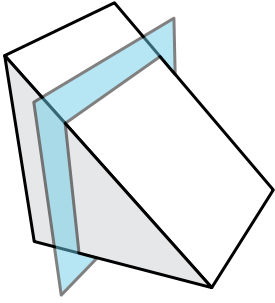

2)

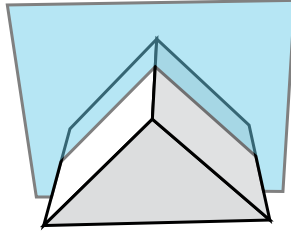

3)

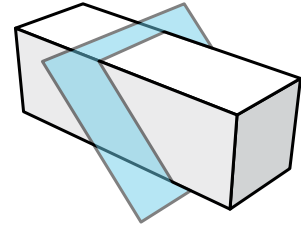

4)

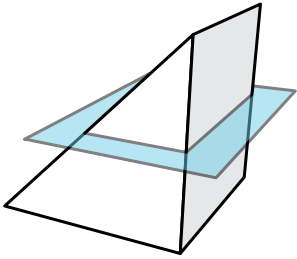

5)

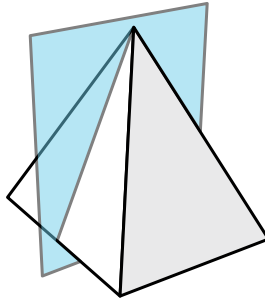

6)

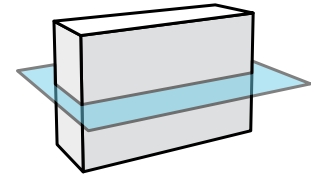

7)

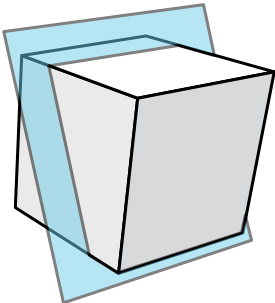

8)

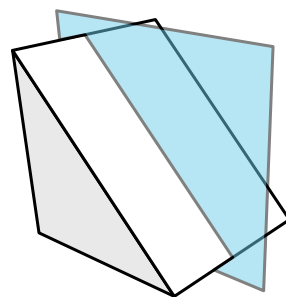

9)

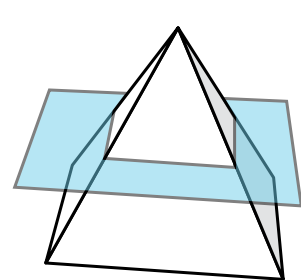



Определите получившуюся 2d фигуру, если 3d фигура будет разрезана как показано.

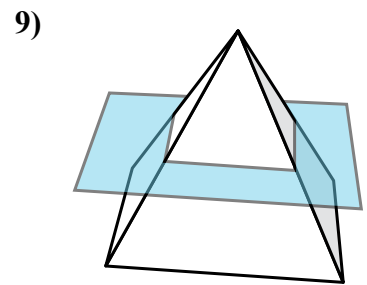
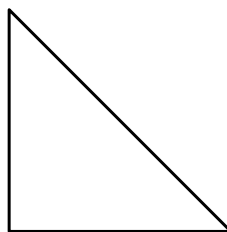
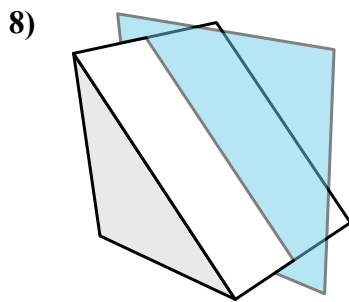
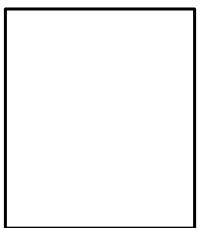
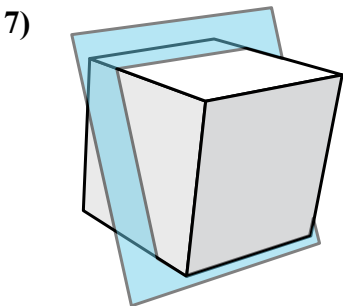
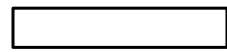
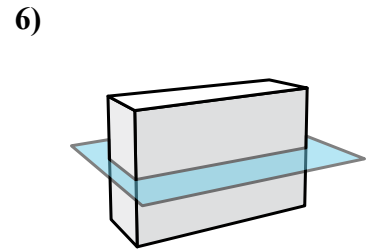
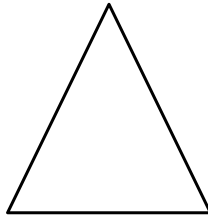
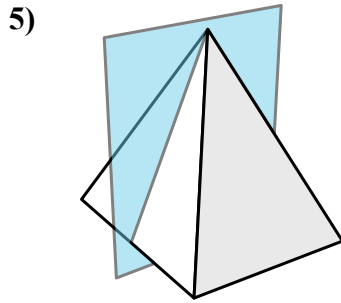
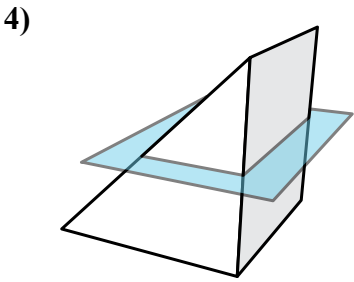
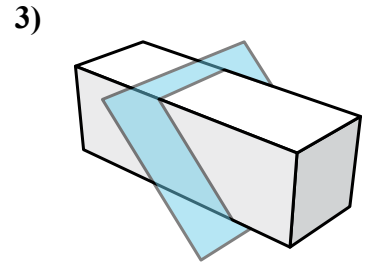
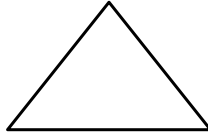
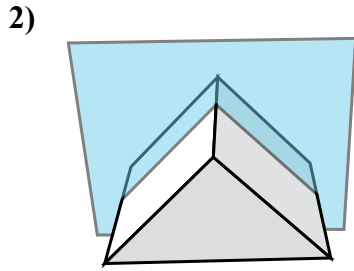
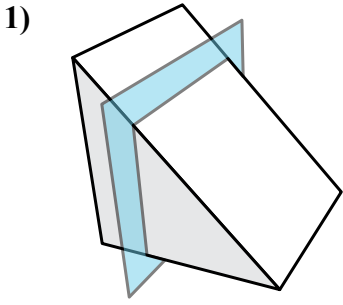



Определите получившуюся 2d фигуру, если 3d фигура будет разрезана как показано.

1)

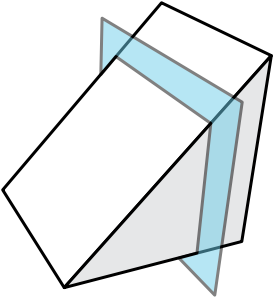

2)

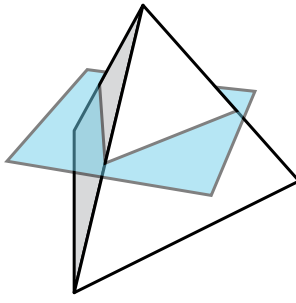

3)

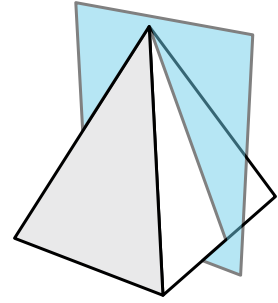

4)

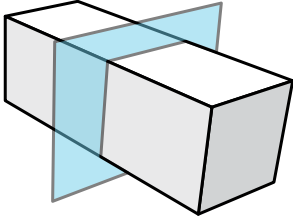

5)

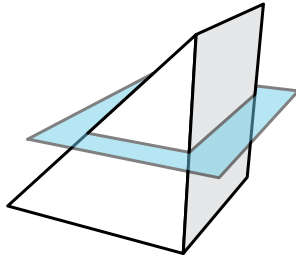

6)

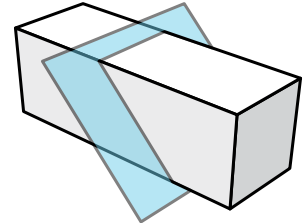

7)

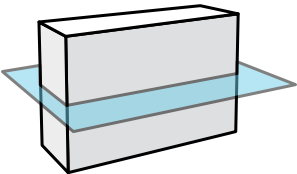

8)

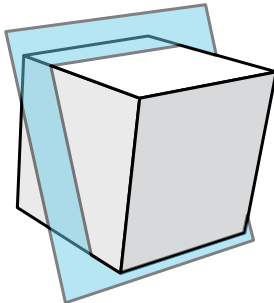

9)

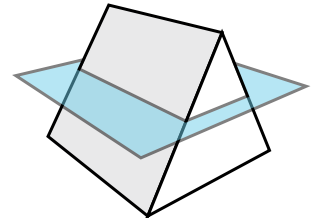



Определите получившуюся 2d фигуру, если 3d фигура будет разрезана как показано.

1)

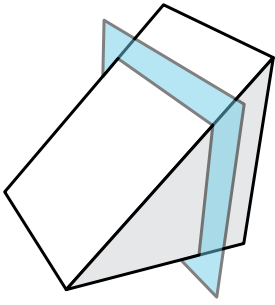

2)

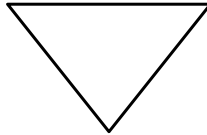
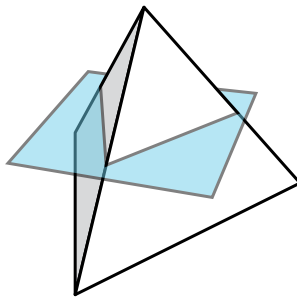

3)

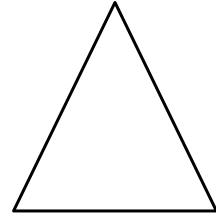
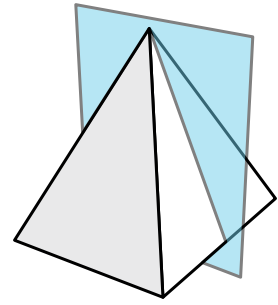

4)

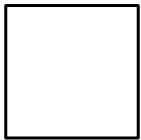
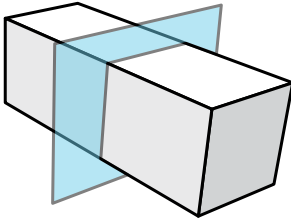

5)

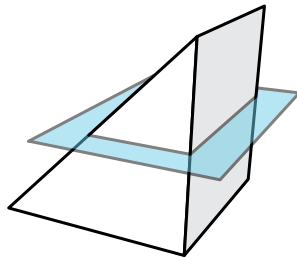

6)

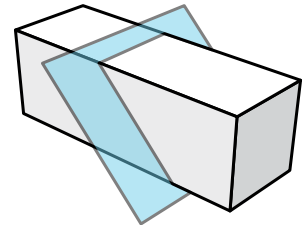

7)

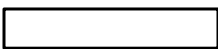
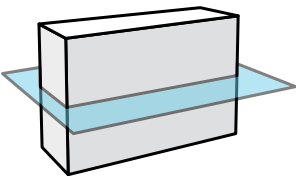

8)

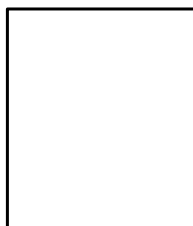
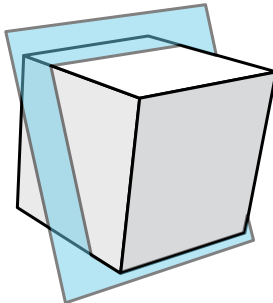

9)

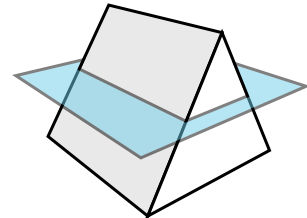





Определите получившуюся 2d фигуру, если 3d фигура будет разрезана как показано.

1)

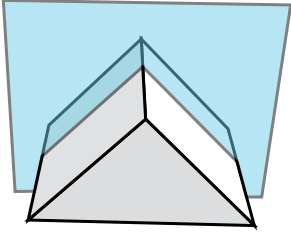

2)

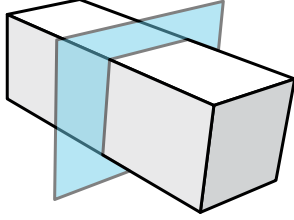

3)

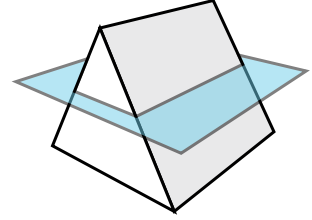

4)

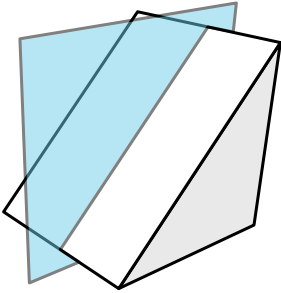

5)

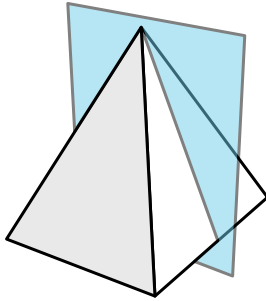

6)

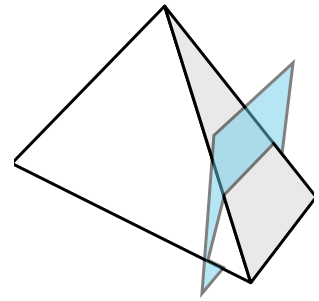

7)

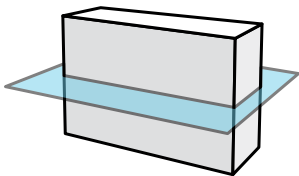

8)

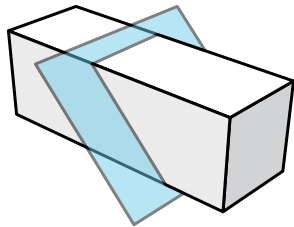

9)

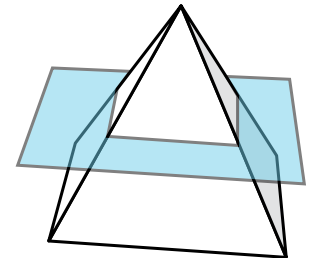



Определите получившуюся 2d фигуру, если 3d фигура будет разрезана как показано.

1)

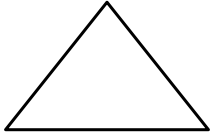
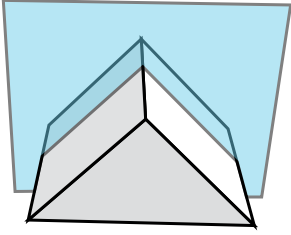

2)

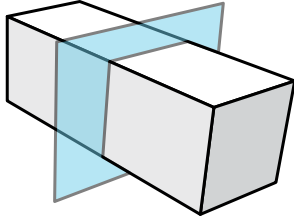

3)

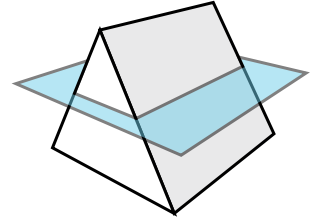

4)

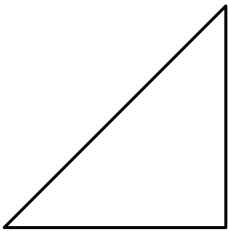
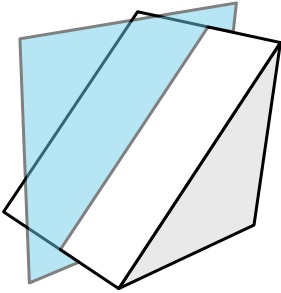

5)

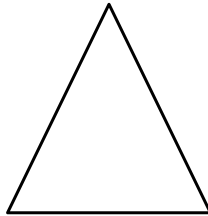
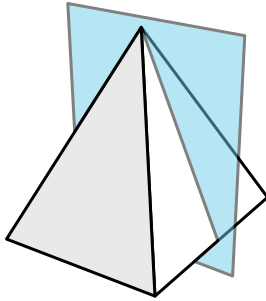

6)

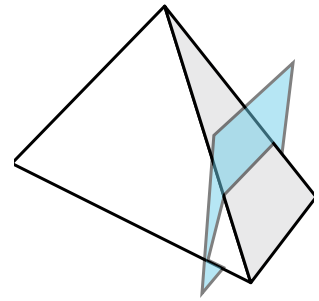

7)

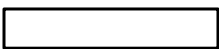
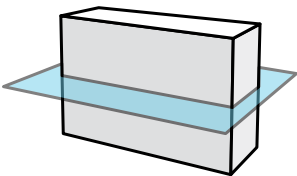

8)

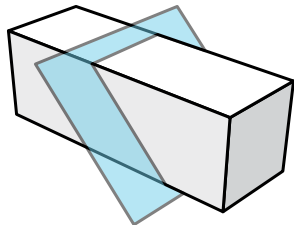

9)

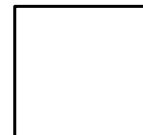
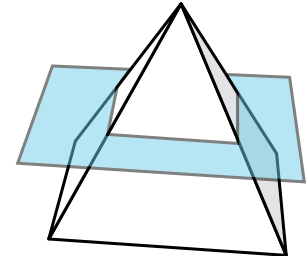



Определите получившуюся 2d фигуру, если 3d фигура будет разрезана как показано.

1)

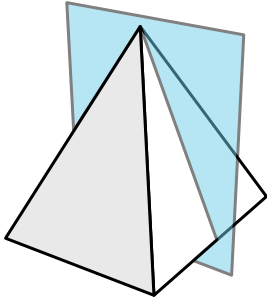

2)

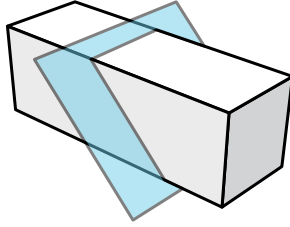

3)

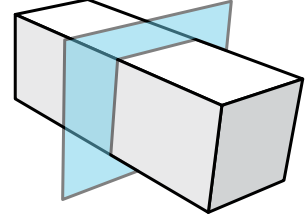

4)

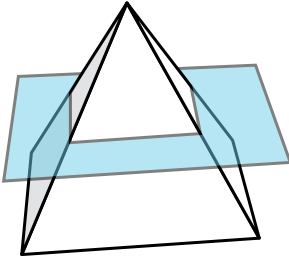

5)

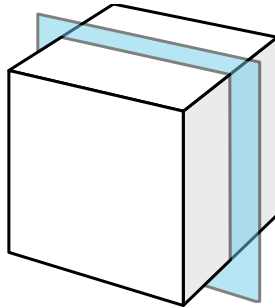

6)

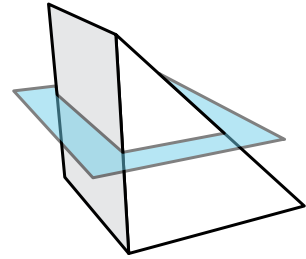

7)

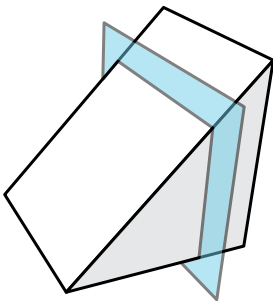

8)

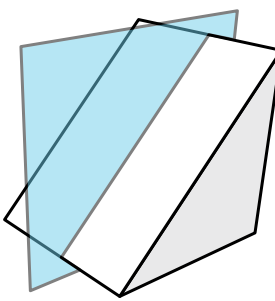

9)

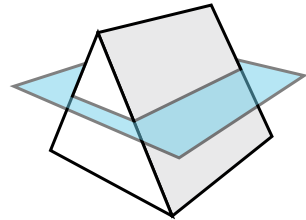



Определите получившуюся 2d фигуру, если 3d фигура будет разрезана как показано.

1)

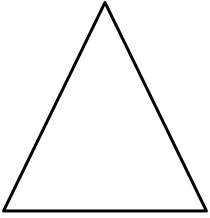
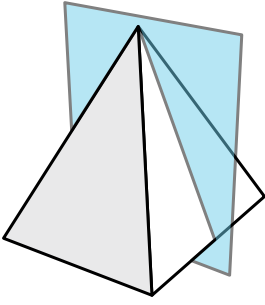

2)

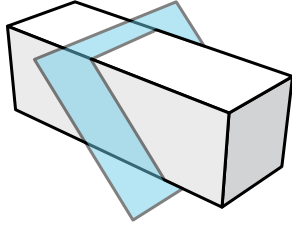

3)

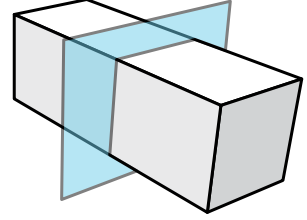

4)

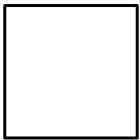
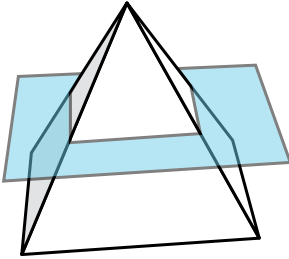

5)

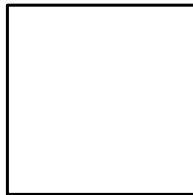
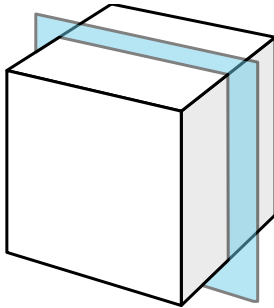

6)

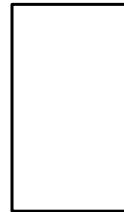
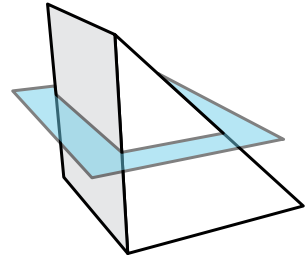

7)

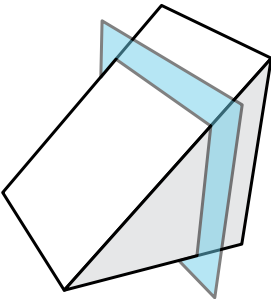

8)

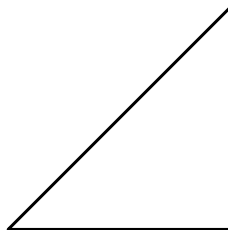
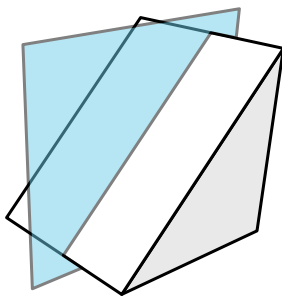

9)

